

Fit 32 Fit 36

L'ENTRETIEN DE VOTRE DOUCHE

Ne jamais utiliser de poudre ou de tampon à récurer. Il suffit de nettoyer la porte avec une solution d'eau et vinaigre, 1 once vinaigre pour 5 onces d'eau. Vous pouvez utiliser un détergent doux mais aucun produit à base d'ammoniac, cela pourrait endommager la surface de la vitre.

THE MAINTENANCE OF YOUR SHOWER

Never use of powder or scouring pads. Simply clean the door with a solution of water and vinegar, 1 to 5. You can use a mild detergent but never use ammoniac, it could damage the glass surface.

PORTE REVERSIBLE

La porte doit être du même côté que le panneau de retour.
The door must be the same side as the side pannel.

REVERSIBLE DOOR

Les instructions montrés au manuel sont pour le montage de la porte droite.
The instructions shown in the manual is for the installation of the right door.

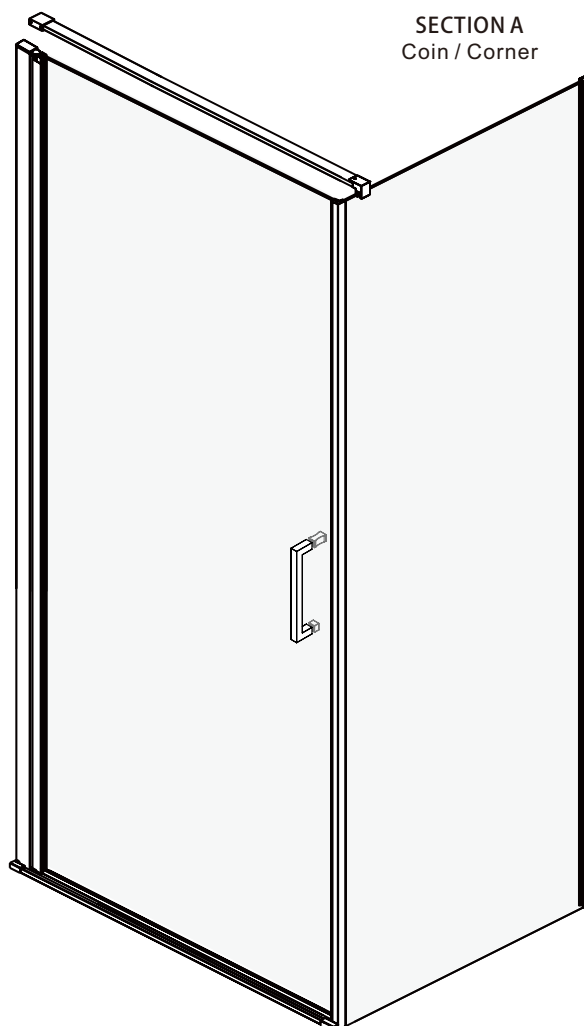

MANUEL D'INSTALLATION / INSTALLATION MANUAL

IMPORTANT

- Inspecter le produit avant de procéder à l'installation.
- La garantie sera invalide si le produit a été installé avec des défauts apparents.

ATTENTION

- Lors de l'installation, l'application de silicone doit être à l'extérieur de la douche, car si appliqué à l'intérieur, cela peut causer des fuites d'eau!
- Veuillez lire attentivement ce manuel d'instruction avant de commencer l'installation.
- Conserver ce manuel pour référence ultérieure.

IMPORTANT

- Thoroughly inspect your product before proceeding with the installation.
- The warranty will be void if the product is installed with a conspicuous defect.

CAUTION

- To prevent leaks, silicone must be applied on the outside of the shower and not on the inside!
- Read all instructions carefully before starting the installation.
- Save this manual for future reference.



ACRYLINE

Tel: 1-855-492-4242 450-704-2323
Fax: 1-866-735-6885
Info@zittagroup.com
www.zittagroup.com

81, Theodore-Viau, Terrebonne,
Quebec, Canada, J6Y 0J8

CONTENU / PARTS LIST

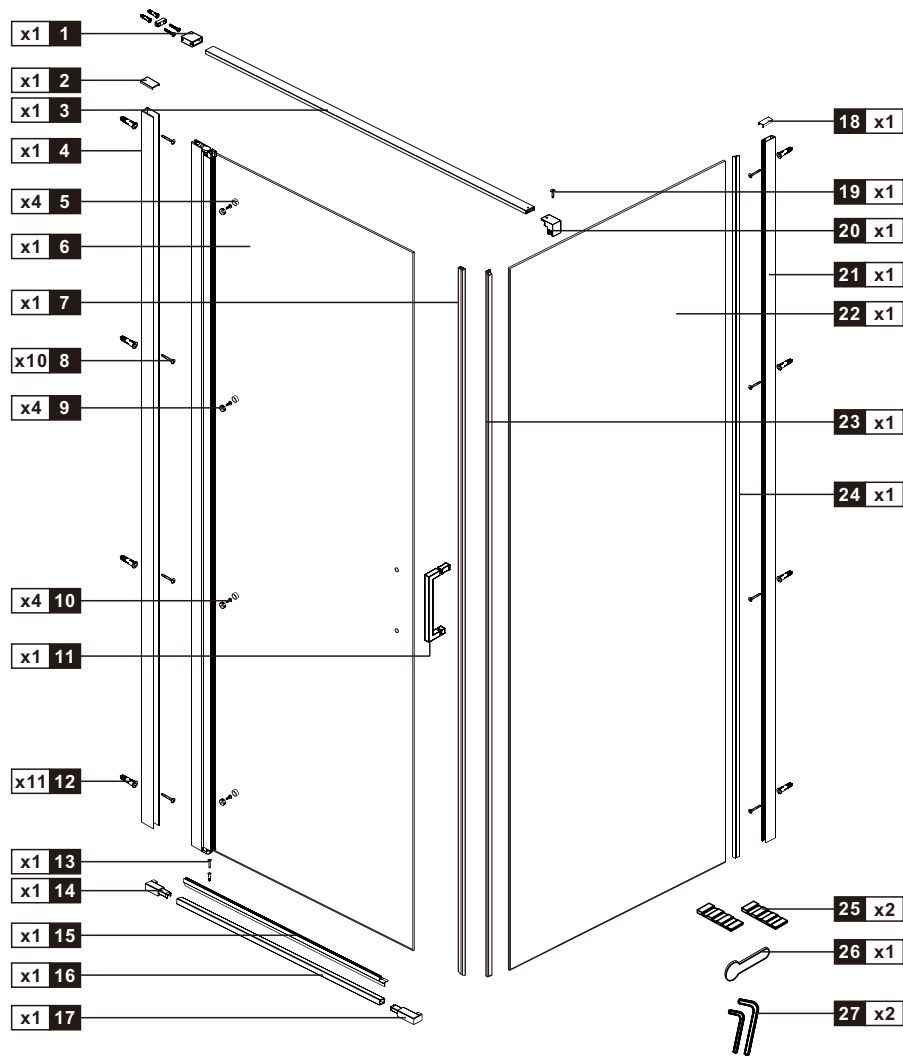

Numéro No	Qté Qty	Description	32" x 32"	36" x 36"	36" x 36" noir
1	1	Attache au mur / Attaches to the wall	PQ032602	PQ032602	PQ032607
2	1	Couvert d'extrusion mural / Channel cap extrusion	PQ032002	PQ032002	PQ032007
3	1	Barre d'attache / Brace bar	PQ032702	PQ032802	PQ032807
4	1	Extrusion murale / Wall Channel	PA005702	PA005702	PA005707
5/9	4	Cache vis / Screw cap	PQ002902	PQ002902	PQ002907
6	1	Porte clair assemblé / Door assembly	PM004322	PM004522	PM004527
7	1	Aimant A 74" 6mm / Magnet A 74" 6mm	PJ012810	PJ012810	PJ012870
8	10	Vis 8 X 1 1/2 " tête plate / Flat head screw 8 X 1 1/2 "	PV000799	PV000799	PV000799
10	4	Vis auto perçante 8 x 1/2" / Self tapping screw 8 x 1/2"	PV001399	PV001399	PV001399
11	1	Poignée Nix / Fit / Rody 2.0 / Nix / Fit / Rody 2.0 Handle	PP003302	PP003302	PP003307
12	11	Cheville murale / Wall anchor	PV000199	PV000199	PV000199
13	1	Vis en V 8 x 1 / Flat screw 8 x 1	PV001899	PV001899	PV001899
14/17	1	Kit ancrage d'anti éclaboussure / Kit bracket for backsplash	PQ032102	PQ032102	PQ032107
15	1	Joint de bas de porte / Bottom door gasket	PJ012910	PJ013110	PJ013170
16	1	Anti éclaboussure / Back splash	PQ032202	PQ032402	PQ032407
18	1	Couvert d'extrusion mural / Channel cap extrusion	PQ032902	PQ032902	PQ032907
19	1	Vis auto perçante 8 x 1/2" / Self tapping screw 8 x 1/2"	PV001399	PV001399	PV001399
20	1	Attache sur la vitre / Attached on the glass	PQ033002	PQ033002	PQ033007
21	1	Extrusion murale / Wall Channel	PA005902	PA005902	PA005907
22A	1	Panneau clair de retour 8 mm 32" / Clear Return panel 8 mm 32"	PG015502		
22B	1	Panneau clair de retour 8 mm 36" / Clear Return panel 8 mm 36"		PG0015602	PG0015602
23	1	aimant 90 74" 6mm / Magnet 90 74" 6mm	PJ013310	PJ013310	PJ013370
24	1	Joint de serrage / Squeeze gasket	PJ013410	PJ013410	PJ013470
25	2	Support d'installation pour vitre / Glass Wedge spacer	PT000199	PT000199	PT000199
26	1	Outil pour joint de serrage / Squeeze gasket tool	PT000399	PT000399	PT000399
27	2	Kit de clé Allen 2.5mm & 4.0mm/2.5mm & 4.0mm Allen key kit	PT002899	PT002899	PT002899

PRÉPARATION/PREPARATION

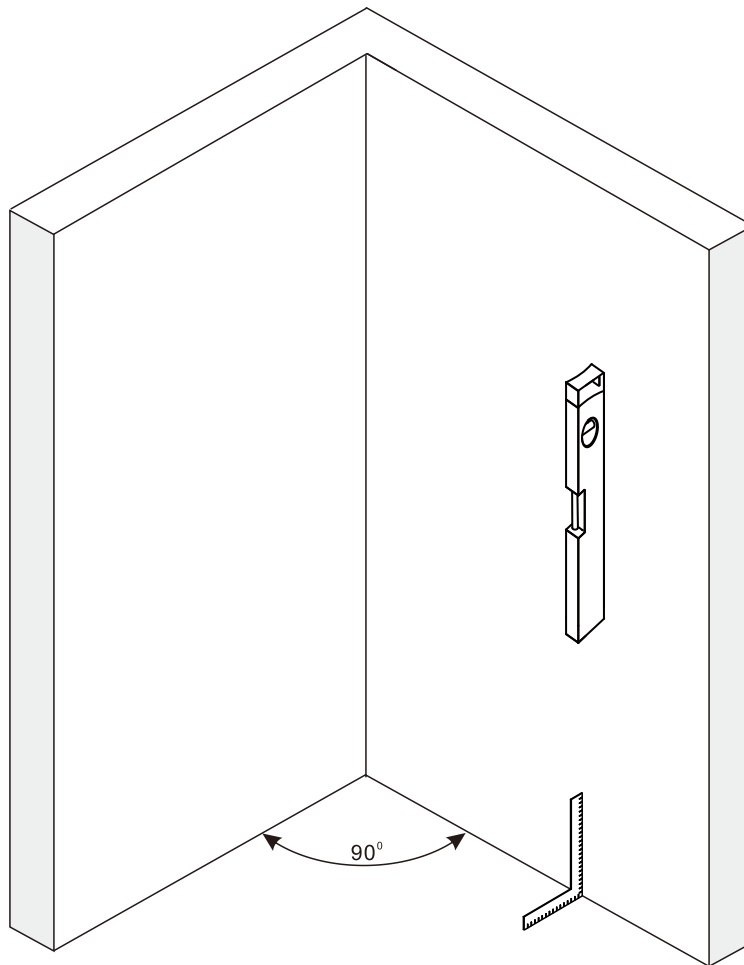

OUTILS ET MATÉRIAUX REQUIS / TOOLS AND MATERIALS REQUIRED

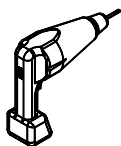

PERCEUSE
DRILL

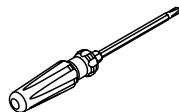

TOURNEVIS
SCREWDR

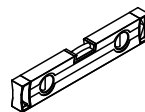

NIVEAU
LEVEL

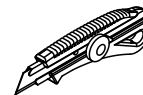

COUTEAU DE PRECISION
PRECISION KNIFE



SILICONE
SILICONE

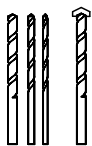

FORETS: 1/8", 3/16" ET 1/4"
*FORET À MAÇONNERIE
DRILL BITS: 1/8", 3/16" ET 1/4"
*MASONRY DRILL BIT

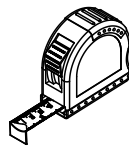

RUBAN À MESURER
MEASURING TAPE



ÉQUERRE
SET SQUARE



CRAYON
PENCIL



MAILLET
MALLET

INSTALLATION EN ALCOVE / ALCOVE INSTALLATION

A 01

ATTENTION !

Attendre 24h avant d'installer votre porte de douche, afin de permettre au mortier et à la finition de sécher complètement.

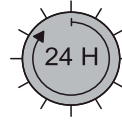

WARNING !

Wait 24h before proceeding with the installation of the shower door. This will ensure that the finish and mortar is dry.

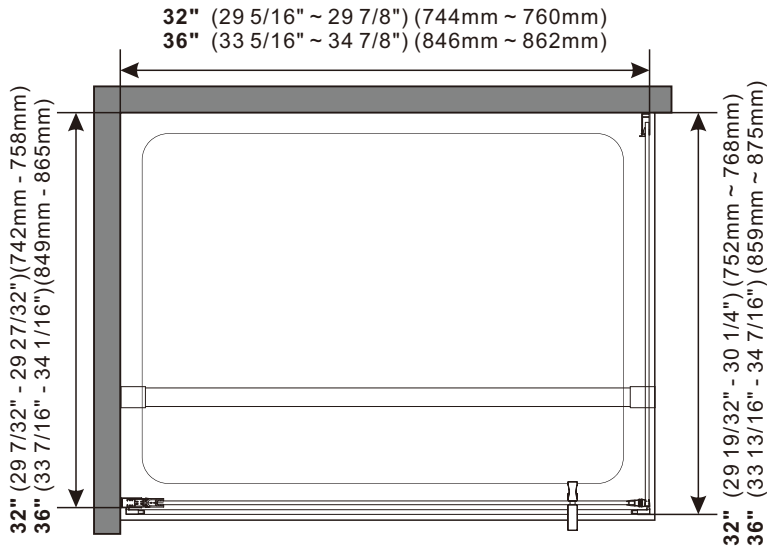

Pour protéger le FINI de votre base de douche. To protect your shower base finish.

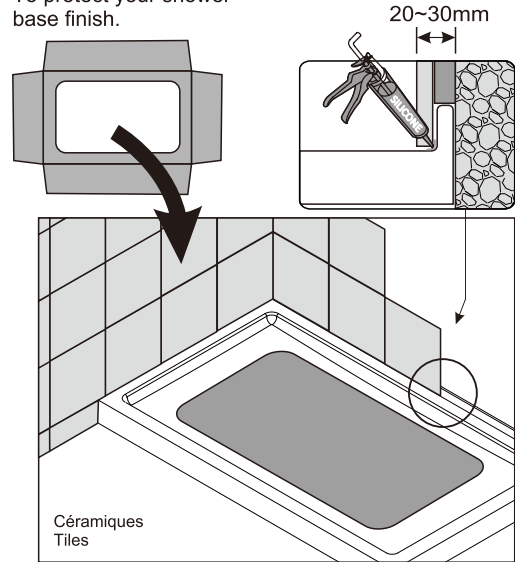

INSTALLATION DU MONTANT MURAL / WALL CHANEL INSTALLATION

A 02

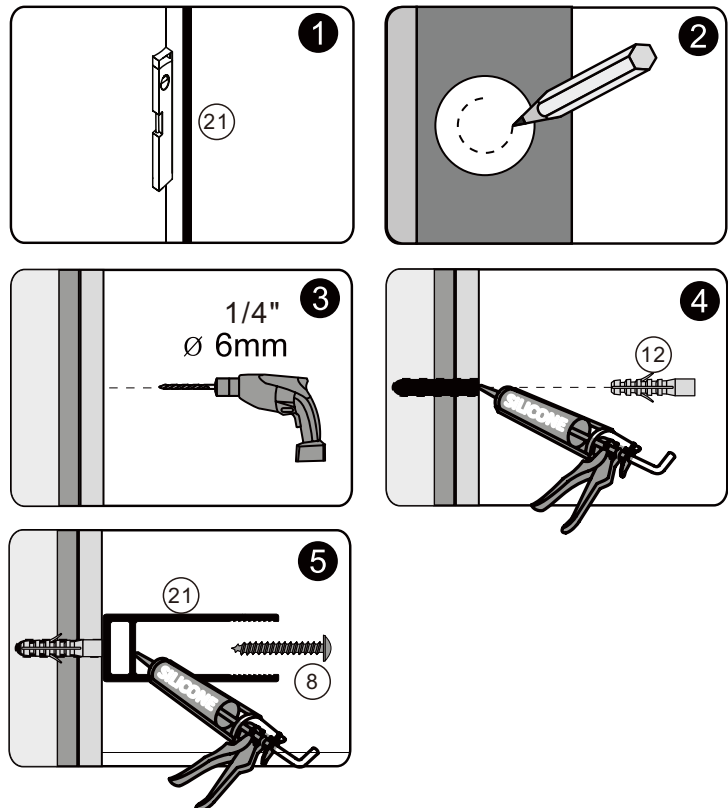
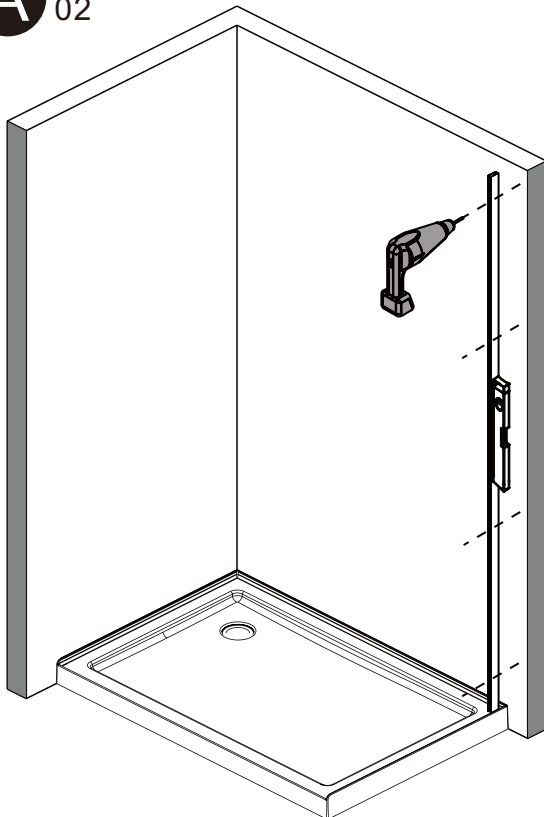

INSTALLATION DU PANNEAU DE RETOUR / RETURN PANEL INSTALLATION

A 03

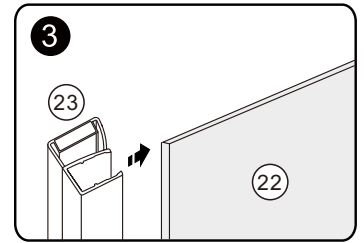
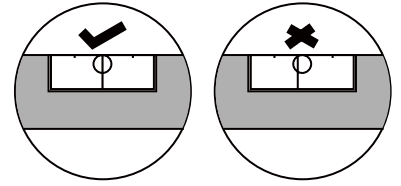
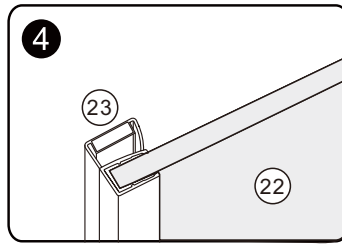
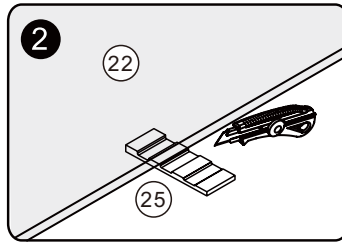
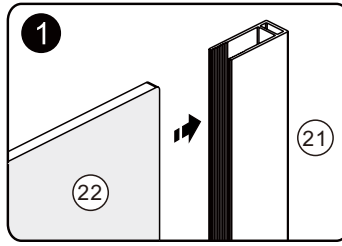
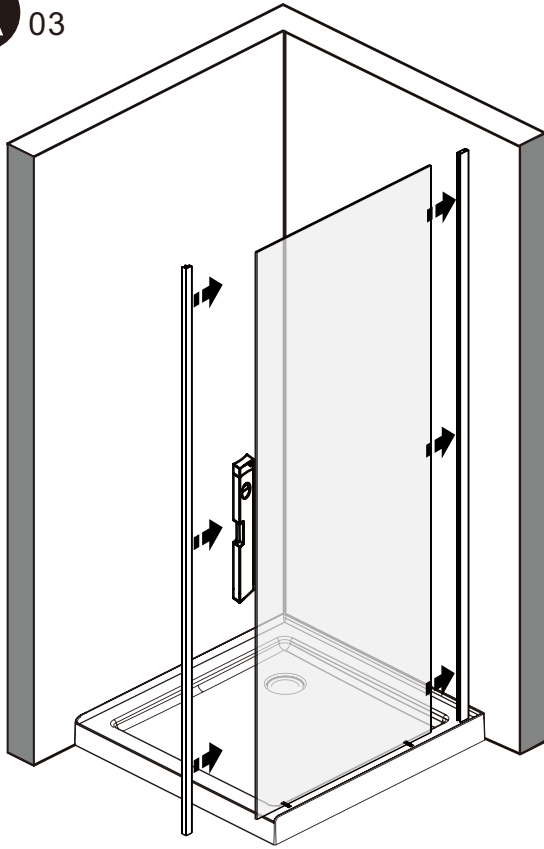

SÉCURISATION DU PANNEAU DE RETOUR / SECURING THE RETURN PANEL

A 04

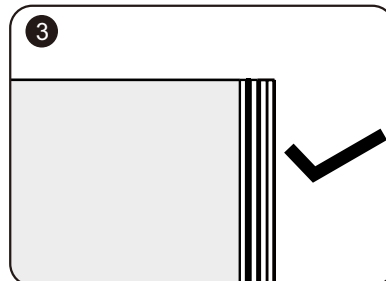
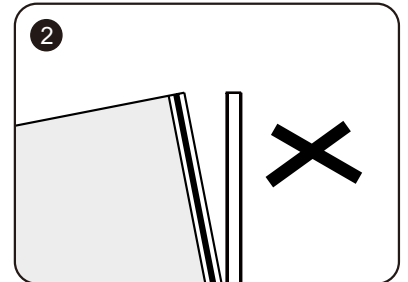
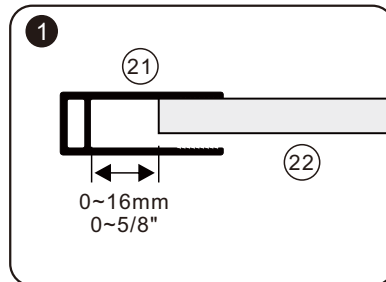
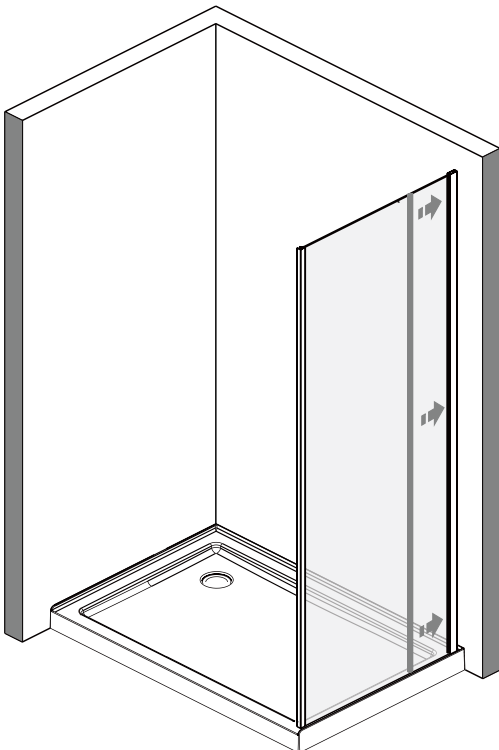

4
24

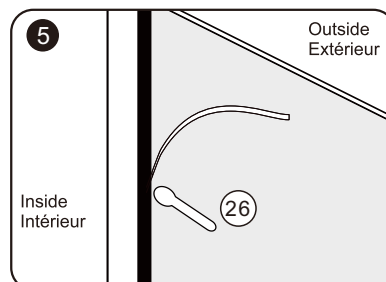

INSTALLATION DU MONTANT MURAL / WALL CHANEL INSTALLATION

A 05

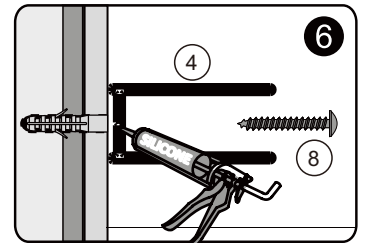
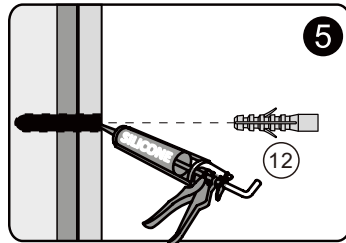
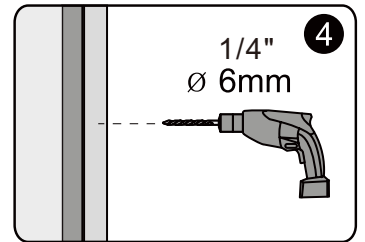
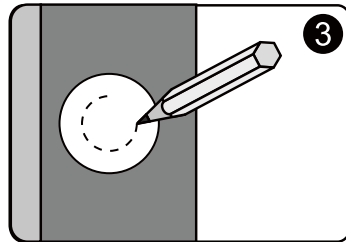
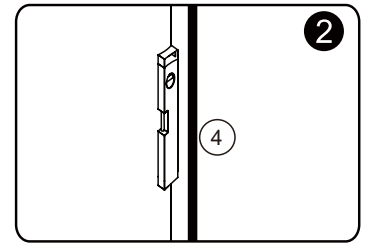
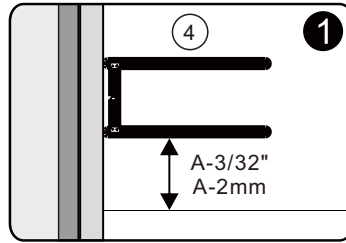
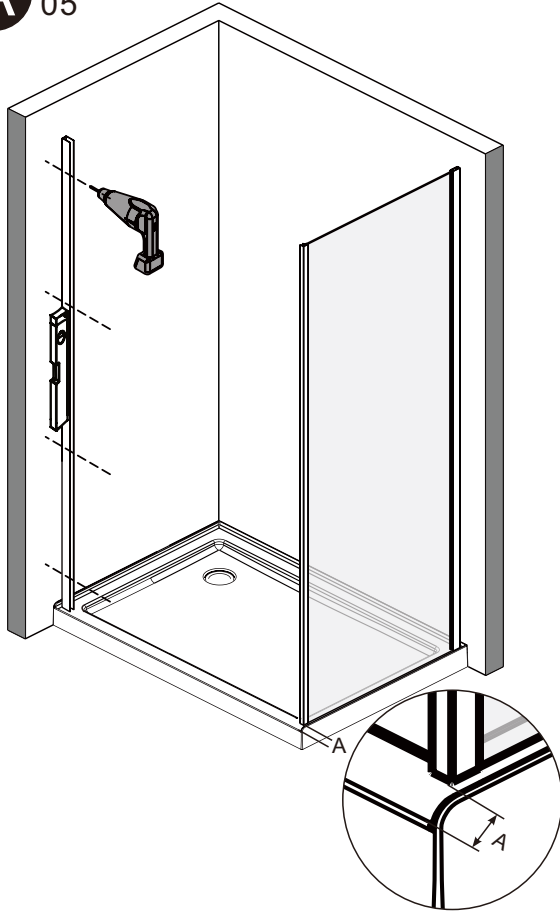

INSTALLATION DE LA PORTE / DOOR INSTALLATION

A 06

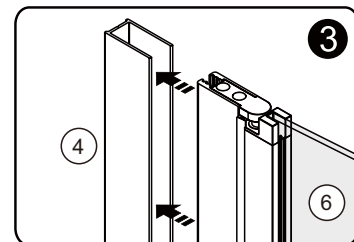
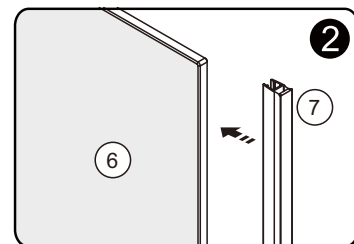
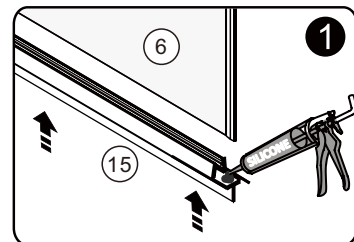
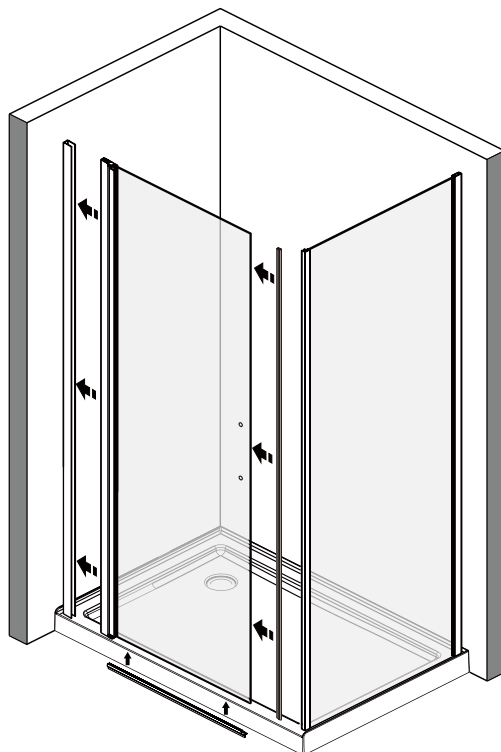

SECURISATION DE LA PORTE / SECURING THE DOOR

A 07

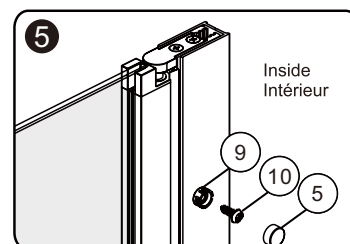
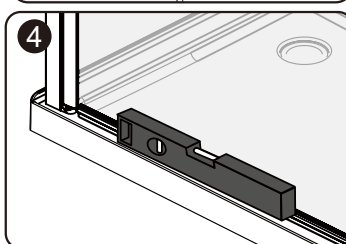
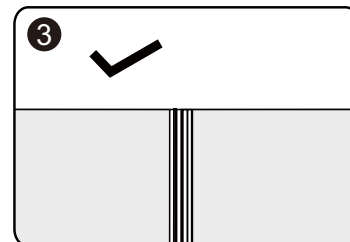
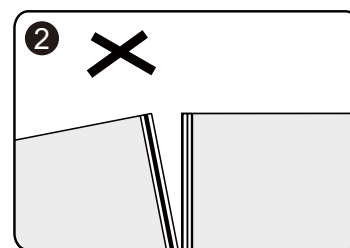
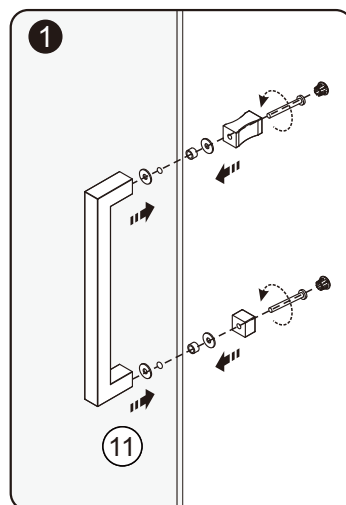
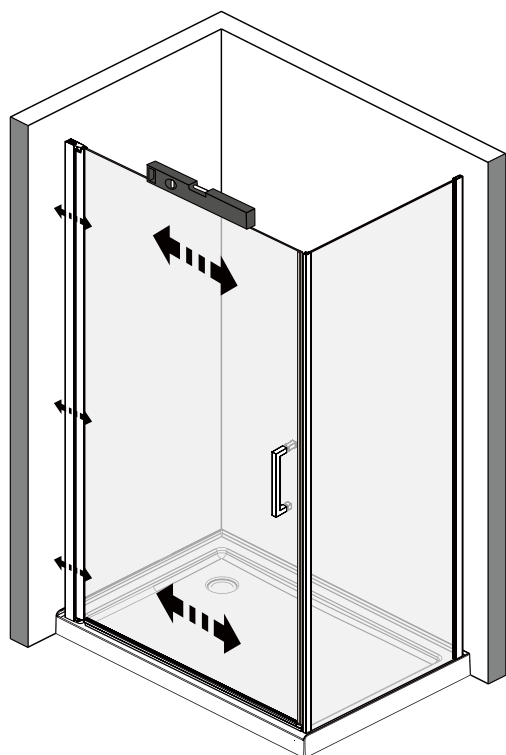

SÉCURISATION DU PIVOT DE PORTE / SECURING DOOR PIVOT

A 08

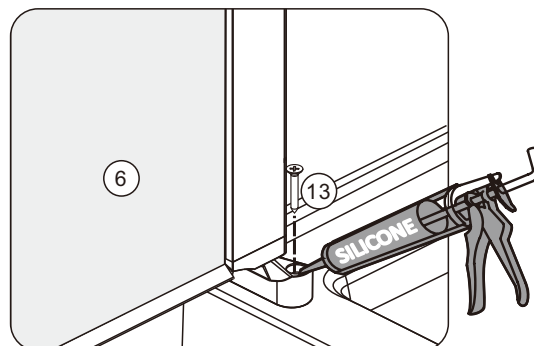
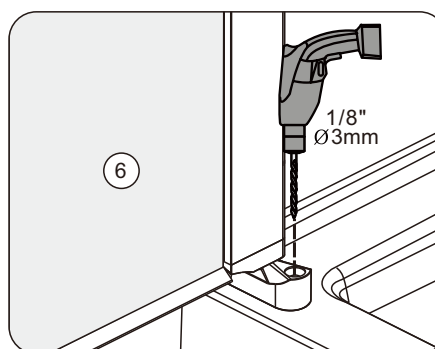
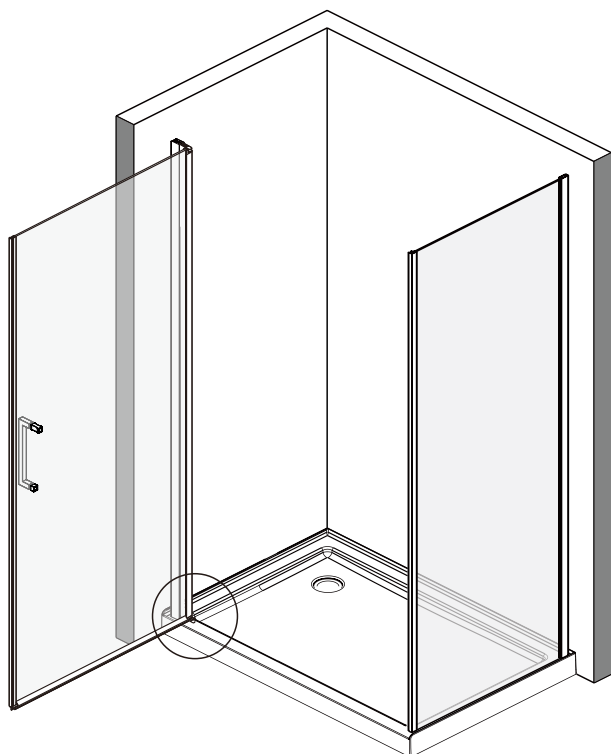

INSTALLATION DE LA BARRE DE SUPPORT / SUPPORT TOP BAR INSTALLATION

A 09

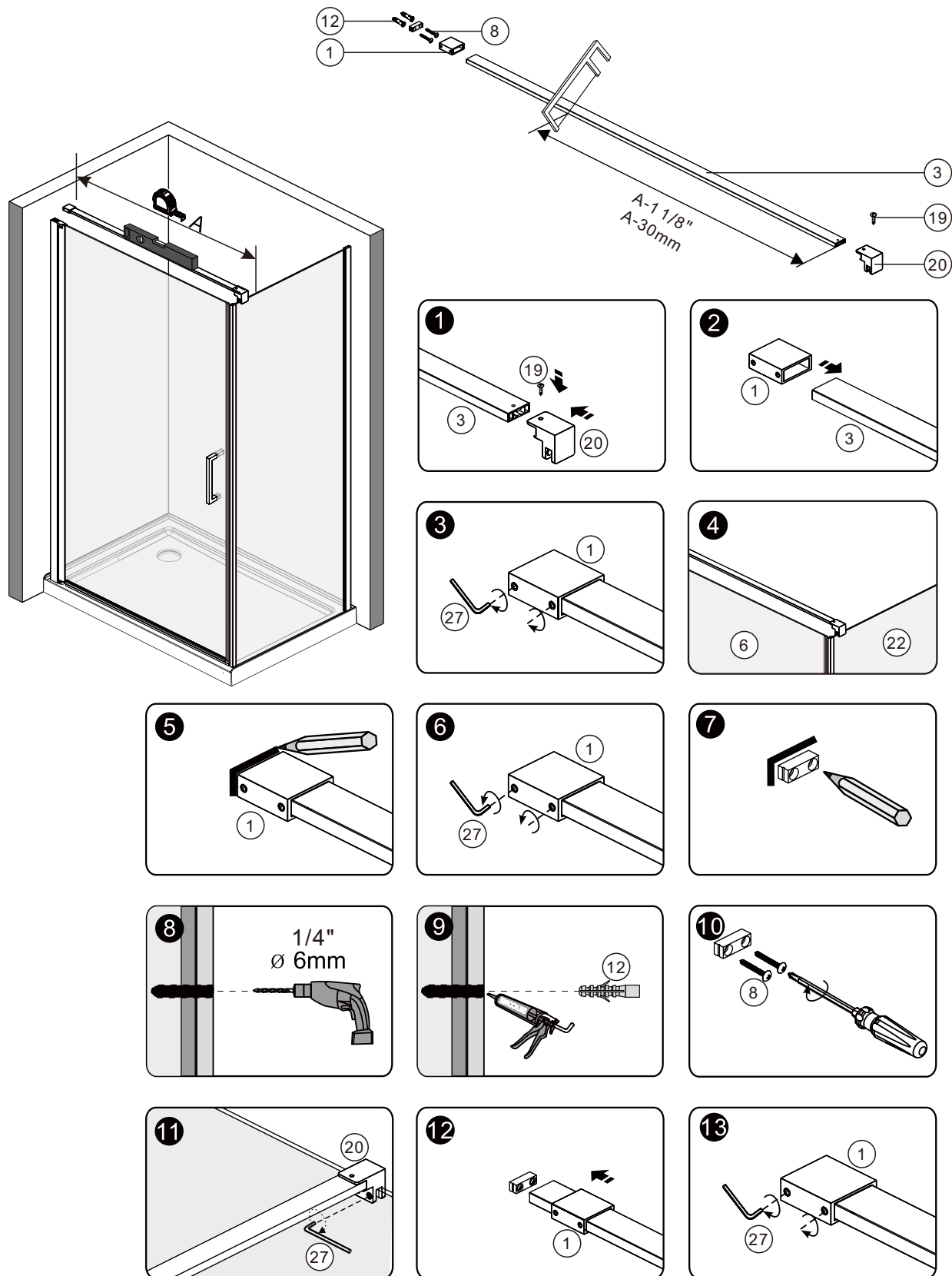

INSTALLATION DE L'ANTI-ÉCLABOUSSURE / BACK SPLASH INSTALLATION

A 10

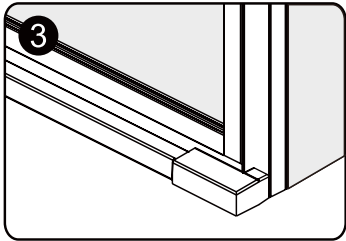
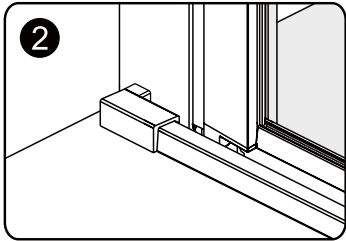
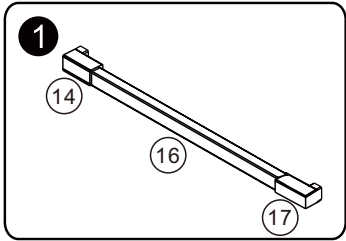
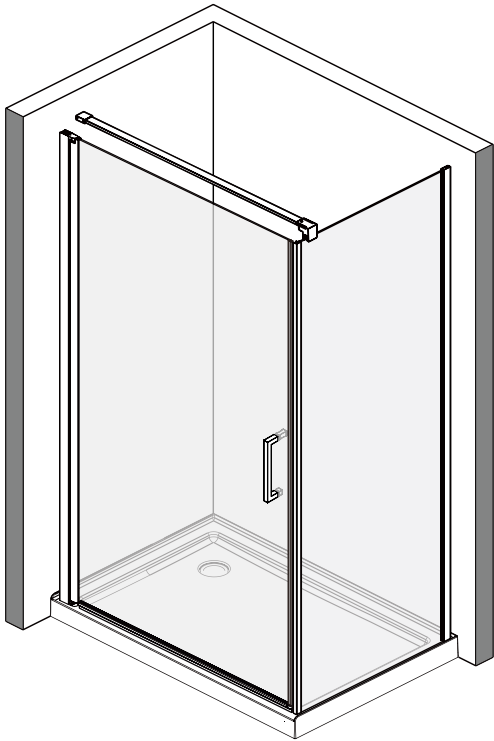

CALFREUTAGE / CAULKING

A 11

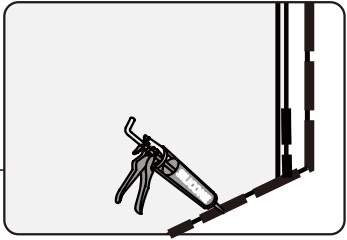
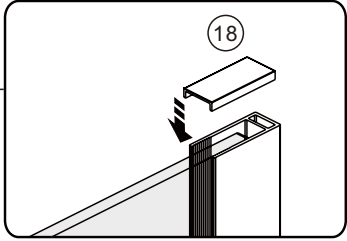
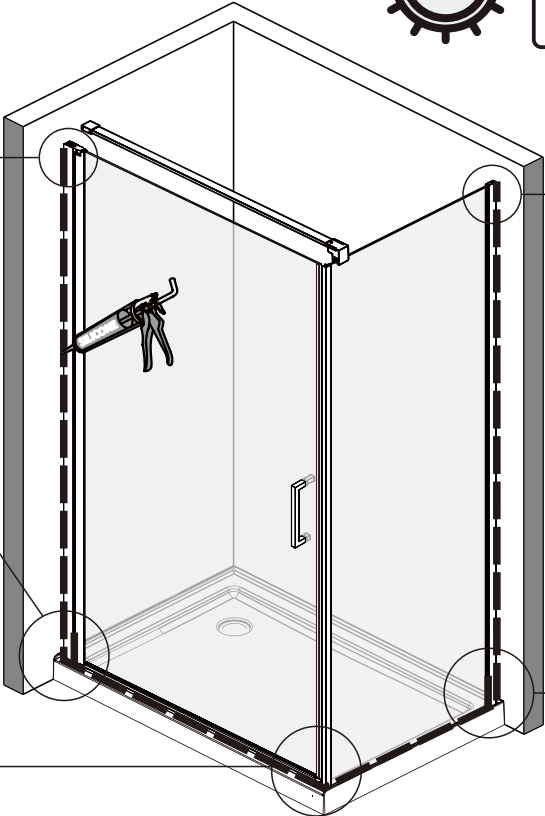
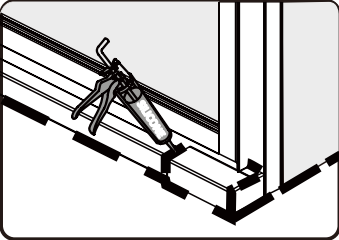
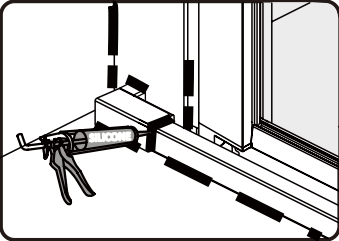
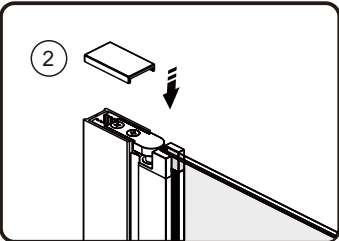
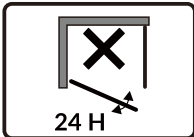
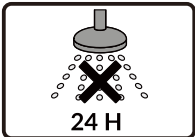

Garantie / Warranty

Garantie

Acrylique	20 years
Système et composantes	3 years
Produits ADA et / ou commerciaux	1 year
Porte de douche	10 years
Roulettes et pentures	Lifetime
Slik stone / solide surface	5 years
Slik cast / fonte	25 years
ZittaClean	10 years
Accessoire, drain & niche	5 years
Colonne de douche	10 years

Suite aux conditions et aux termes décrits ci-dessous, ZittaGroup garantit que le produit vendu est conforme à ses spécifications et qu'au moment de la vente le produit est exempt de tout vice et/ou défaut de fabrication. Cette garantie n'est applicable que pour le premier acheteur/utilisateur et ce pour la première année à partir de la date d'achat. Cette garantie ne peut pas être transférée à une tierce personne. Cette garantie exclue tout frais relié au déplacement, frais d'installation et/ou déinstallation et aux frais de transport.

La présente garantie ne couvre pas les défauts ou bris résultant d'Acte de Dieu, d'accident, de catastrophe, d'abus, de négligence, d'une installation non conforme, de l'ajout ou de la suppression de la pièce ou de l'équipement, d'une mauvaise utilisation, de variation de température intense, d'exposition aux produits chimiques et à des abrasifs de tout genre ou de tache provoquée par différents types d'eau tel que l'eau ferreuse ou alcaline.

ZittaGroup ne peut être tenu responsable des dommages directs et indirects causés ou résultants de cas fortuits, des frais de main d'oeuvre, frais divers, perte de temps, matériaux ou d'autres coûts relatifs à l'application ou au remplacement du produit ou à l'une de ses composantes. Dans l'éventualité où un défaut de fabrication se manifeste, l'acheteur/utilisateur devra avoir suivi les instructions d'installation inscrites au manuel d'instructions devra présenter une preuve d'achat ainsi qu'une preuve d'installation par un professionnel reconnu par l'industrie de la reconstruction. ZittaGroup pourra à son entière discrétion, réparer ou remplacer le produit sur une base au prorata du prix alors en vigueur. ZittaGroup se réserve le droit de faire inspecter, sur le site, la défectuosité par un représentant de son choix. Aucun retour ne sera accepté sans l'autorisation au préalable de ZittaGroup.

Entretien et prévention

ZittaGroup recommande L'entretien des surfaces avec un chiffon humide et du savon doux. L'utilisation de produits abrasifs, grattoir, brosse ou tout autres objets pouvant endommager la surface du produit est à proscrire et annulera la présente garantie. Vous référer à la section Nettoyage et entretien pour des directives spécifiques d'entretien du fabricant.

Warranty

Acrylic	20 years
System and components	3 years
ADA and / or commercial products	1 year
Shower doors	10 years
Roller and hinges	Lifetime
Slik stone / solid surface	5 years
Slik cast / cast iron	25 years
ZittaClean	10 years
Accessory, drain & niche	5 years
Shower column	10 years

Following the terms and conditions described below, ZittaGroup warrants the product to be free from defects in workmanship from the date of purchase. This warrant applies to the initial date of purchase from an authorized dealer for the owner/end-user only. This warranty cannot be transferred to a third party. This warranty excludes any expenses related to shipping, handling and/or installation fee.

The present warranty does not cover the defects or breaking resulting from any Act of God, accident, catastrophe, abuse, negligence, improper installation, addition or removal of parts or equipment, of misuse, intensive variation of temperature, exposures to chemicals and/or abrasives of any kind, stains caused by different types of water such as ferrous or alkaline water.

ZittaGroup cannot be held responsible for the direct or indirect damage caused by or resulting from fortuitous occurrences, from the expenses of sundries, labor, wastes of time, material or any other cost related to the application or the replacement of the components. In the eventuality that a manufacturing defects appears, the owner/enduser must have followed the instructions described in the installation manual, have in his possession the proof of purchase as well as a proof of installation by a professional recognized by the construction industry. ZittaGroup will, at his discretion, repair or replace the product based on the selling price at the time of purchase. ZittaGroup reserves the right to inspect, on the site, the defect by a representative of its choice. Any return of goods will not be accepted without the written authorization from ZittaGroup.

Maintenance and prevention

ZittaGroup recommends the use of a wet cloth and soft soap for the maintenance of surfaces. The use of gritting scraper, brushes or any other scouring object which can damage the surface of the product is to be proscribed and will cancel the present warranty. Refer to the Care and cleaning of your drain section of the owner's manual for the manufacturer recommendations.



ACRYLINE

Tel: 1-855-492-4242 450-704-2323

Fax: 1-866-735-6885

Info@zittagroup.com

www.zittagroup.com

81, Theodore-Viau, Terrebonne,
Quebec, Canada, J6Y 0J8